

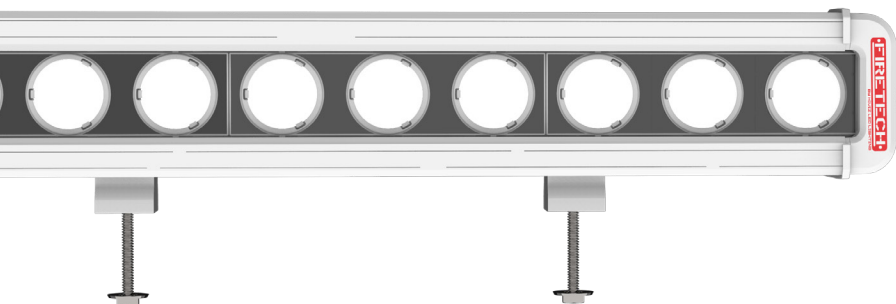

MINIBROW LIGHT INSTRUCTION MANUAL

FireTech Single Stack MiniBrow Light

FT-MB-3-**-* to FT-MB-39-**-* models



HiViz LED Lighting
HiViz Lighting, Inc
Phone: 703-662-3458
Email: firetech@hizizleds.com
PO Box 565, Naples, NC 28760



TABLE OF CONTENTS

Safety Regulations & Warranty3

MiniBrow: What’s Included4

Technical Specifications5

Old and New System.....6-7

Installation Instructions8

Wiring Information9

Accessories and Replacement Parts10

References11



SAFETY NOTICE & WARRANTY

WARNING: INSTALLATION MUST BE CONDUCTED BY A QUALIFIED TECHNICIAN.

IMPROPER INSTALLATION CAN RESULT IN INJURY OR DEATH.

- Installation must be conducted by a qualified automotive electrician or emergency vehicle technician in accordance with the applicable NFPA standard(s) and procedures (Including but not limited to NFPA 1901, 1906, 1911, 414, 1900)
- Improperly installed, aimed, or operated lights can create significant hazard to motorists which can result in collision. Ensure light fixtures are installed and operated such that their beam does not shine into oncoming traffic
- All circuits must be fused at 125% of the rated power consumption of the loads on the circuit
- A voltage drop greater than 10% in the power feed to a fixture could be an indicator of an under-sized conductor. Use of improperly sized conductors will, at a minimum, result in poor performance, and at a maximum could result in fire
- Verify input voltage is within fixture range before installation. Voltage range information can be found in this manual or printed on the fixture body
- The use of personal protective equipment (safety glasses and gloves) is highly recommended
- Allow proper cooling time before handling the fixture if it has been installed & powered to prevent burns
- Any modifications to the fixture will void warranty and are not authorized by the manufacturer
- Always inspect the fixture for any damage prior to installing and DO NOT install if any damage is present



PLEASE READ ALL INSTRUCTIONS BEFORE INSTALLATION



Warranty Information: Full policy available Online at www.hivizleds.com/warranty

- Proof of purchase may be required to validate warranty. All FireTech products are warranted for the useful service life of the vehicle for which they were first installed
- Improper installation, accident, physical damage, neglect, and normal wear and tear are not covered under warranty
- Lights operated in environments over 150° Fahrenheit are not covered under warranty
- All advance-exchange warranty claims must be validated with HiViz Technical Support prior to issuance of a shipping label. Failure to return defective product will result in an invoice for the full replacement value of the product
- HiViz Lighting will repair or replace defective product at its discretion. Replacement product will be in similar or better cosmetic condition than the defective part
- Warranties should be handled through the dealer/reseller the product was purchased from; customer is responsible for delivery
- If product is found to have damage not covered under warranty, customer will be responsible for return shipping charges and/or cost of repair
- Non-warranted items can be repaired at the customer's expense of parts and labor, at the discretion of HiViz LED Lighting, who will provide an estimated repair cost before proceeding with the repair



WHAT'S INCLUDED

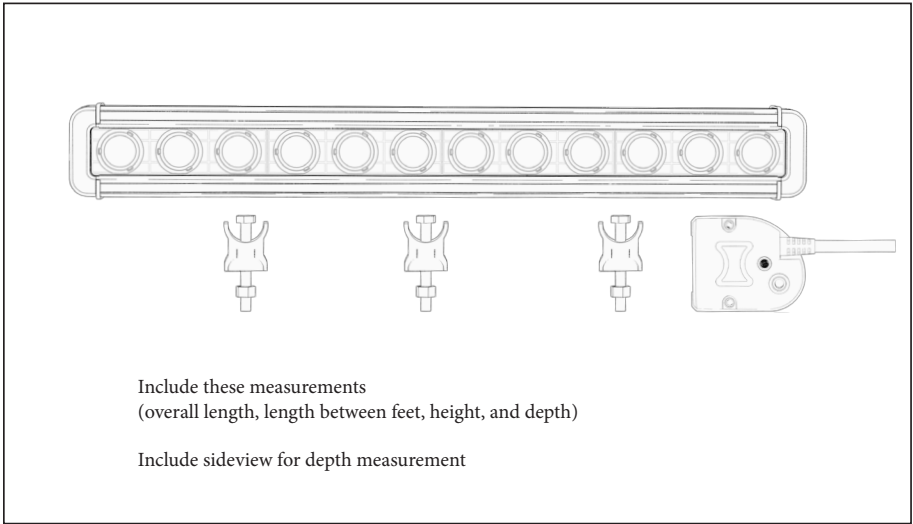

PIECES INCLUDED

- 1** Minibrow light
- 2** Center Drop-in Pedestal Mounting feet (Quantity depends on length)
- 3** End Piece Drop-in Pedestal Mounting feet (Quantity 2)
- 4** Wiring Harness “Whip” (Quantity 2)
- 5** Allen Wrench

TOOLS REQUIRED

- 10mm Wrench or Socket
- “D” size or 1/4” Drill Bit
- Measuring Tape
- Basic Automotive Wiring Supplies

Notice:

Use hand-tools to tighten all hardware.
Use of power tools will cause permanent gauling and seizure of hardware.



TECHNICAL SPECIFICATIONS

SINGLE STACK MINIBROW

ITEM #	ACTUAL LENGTH	WATTS	FEET #	AMP DRAW
FT-MB-3-**-*	4.65"	15	2	1.25
FT-MB-6-**-*	8.43"	30	2	2.5
FT-MB-9-**-*	12.21"	45	2	3.75
FT-MB-15-**-*	19.77"	75	2	6.25
FT-MB-21-**-*	27.33"	105	3	8.75
FT-MB-24-**-*	31.11"	120	3	10
FT-MB-27-**-*	34.89"	135	3	11.25
FT-MB-33-**-*	42.44"	165	4	13.75
FT-MB-39-**-*	50.00"	195	5	16.25

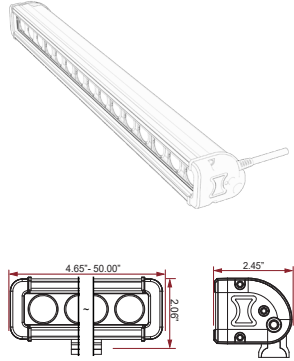

CONFIGURATION INFORMATION

CONFIGURE PART

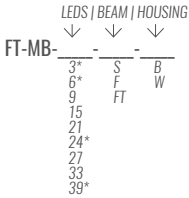

EXAMPLE CONFIGURATION

FT-MB-33-S-W
 MINIBROW - 33 LED - SPOT - WHITE

AVAILABLE BEAM PATTERNS

S=SPOT
LONG DISTANCE



F=FLOOD
AMPLE COVERAGE

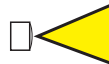

FT=FireTech Optics
BEST OF BOTH



HOUSING COLOR OPTIONS

* ADD "-W" OR "-B" TO DENOTE WHITE OR BLACK HOUSING
 ** SPECIFY SPOT, FLOOD, OR FIRETECH OPTICS

W=WHITE



B=BLACK



OLD SYSTEM

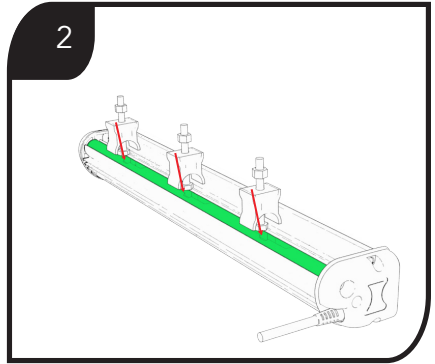
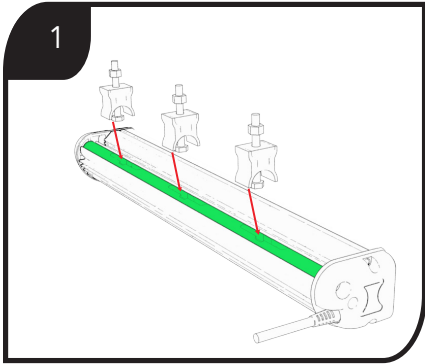

Steps 1-2: Align feet with hole in extrusion. Drop into place so they latch to extrusion.

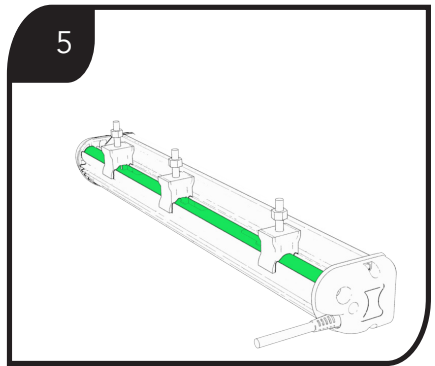
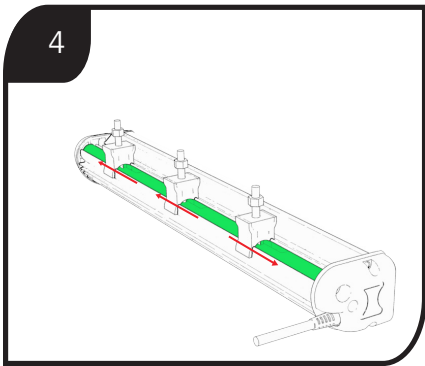

Steps 3-4: Then slide each foot to the outermost edge of the extrusion. (Left foot to far left side of hole, Right foot to far right side of hole, and the middle foot to either edge of the middle hole.)



NEW SYSTEM

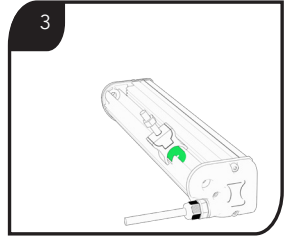
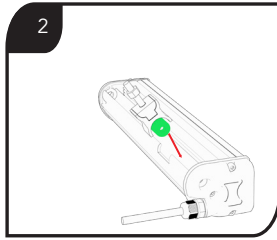
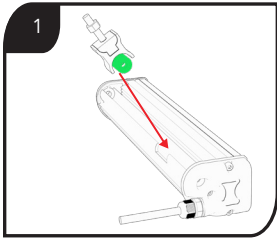

Steps 1-3: Begin by Lining foot up with gap, angle so that it drops in, and latches to extrusion.

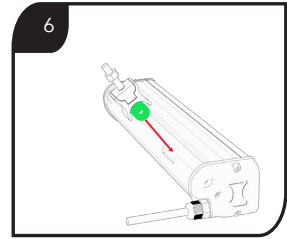
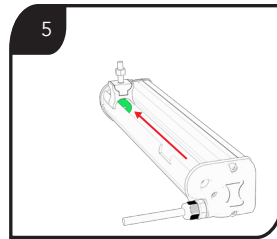
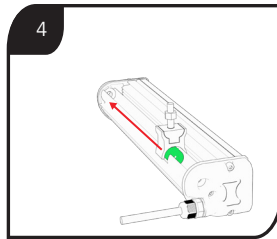

Steps 4-6: Once in place and gripping the extrusion, slide foot to the end of the bracket.

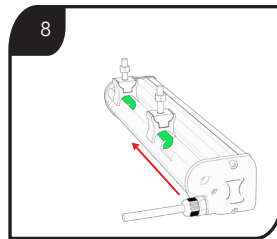
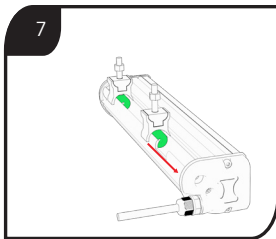

Steps 7-8: Repeat process with next foot.



INSTALLATION INSTRUCTIONS

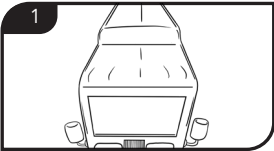

1. Get a general idea of where you plan to install the light by holding it up to the surface of the cab.

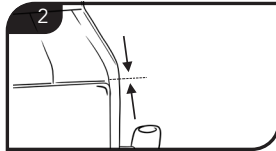

2. Define the placement where the light is as close as practicable to the front edge of the apparatus.

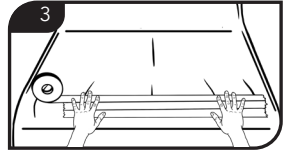

3. Create a tape layer to help identify mounting locations for feet and overall fixture fit.

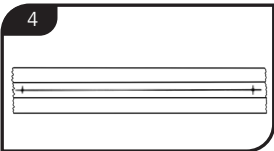

4. Mark each edge of fixture, and straight out from each bolt when laying it out on top of the tape.

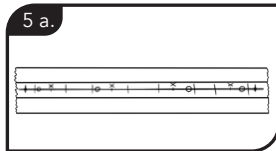

5 a. For the embedded rail mounting system, mark out center and edges of each foot cavity. X out the centers (do not drill there) and circle a spot between the outer edges and the center for drilling into.

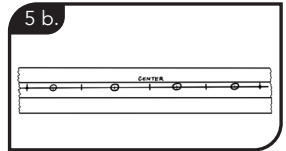

5 b. For the drop-in foot mounting system, simply choose even spacing for where you want feet to mount (measure line, and divide by number of feet, and mark with a dot).

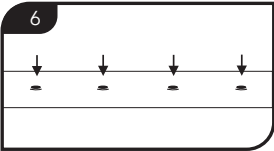

6. Drill holes, an M8 bolt is used, so the drill bit needs to be slightly larger.

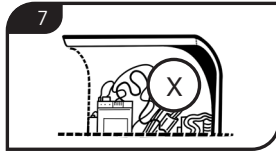

7. Go inside the cab and ensure there are not any obstructions (AC parts, wires, etc).

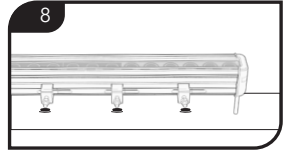

8. Put mounting feet in the light, slide slugs in the holes, stick above light, line them up, drop foot down into hole.

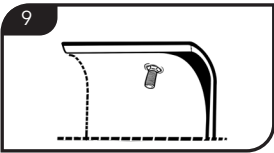

9. Stick washer or nut bolt from within side the cab and tighten it down (10mm nut, so use a 10mm wrench). Do not use power tools, they will strip it.

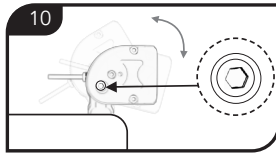

10. Once installed and tightened down, the whole light can be tilted and angled. For best practice, angle the fixture approximately 3 degrees downward.

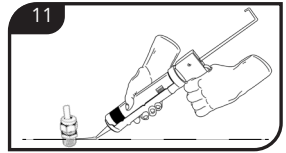

11. Install a wire gland to run wires and cables through. Seal all bolt passages with silicone.



WIRING INFORMATION

1. Wiring:

- The 3 pin variety is red, black, and yellow
- The 2 pin variety is red and black
- The black wire is always ground
- The yellow wire and the 2 red wires will be 12 volts each

2. One of the red wires will be spot, flood, or scene, the other red will be the other spot, flood, or scene. One yellow wire is for marker lights, the other yellow is the other of the 3 circuits

3. When installing, you can tap **12 volts** to each of the wires to see what part lights up and to see what happens

4. Both black wires need to be hooked up to ground

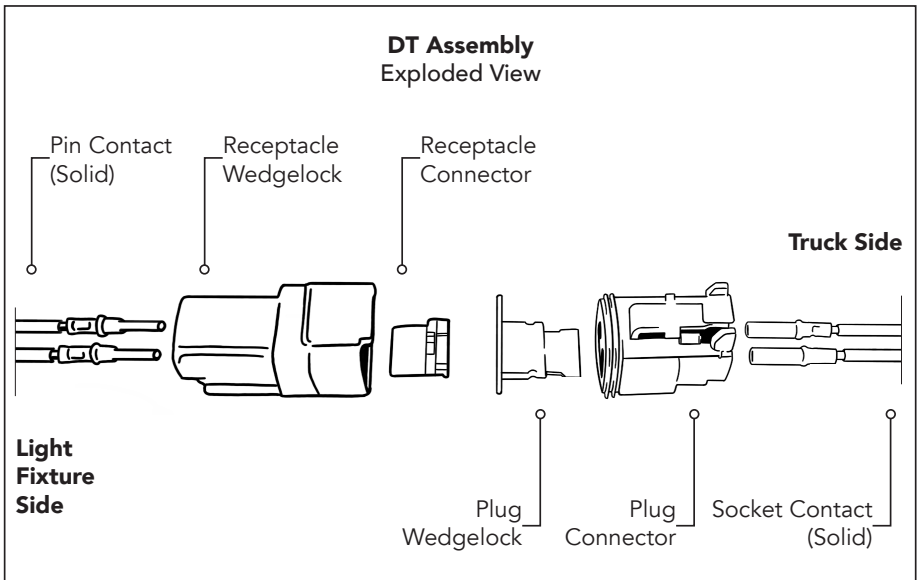

ACCESSORIES & REPLACEMENT PARTS

ACCESSORIES

1. P-MB-LFOOT-*

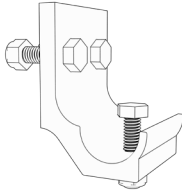

2. P-MB-R3V2FOOT-*

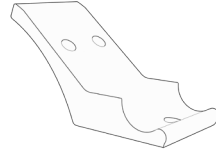

3. P-MBECM

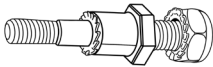

REPLACEMENT PARTS

1. Drop-in foot - new style

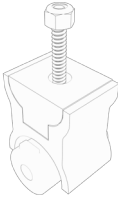

2. Drop-in foot - old style

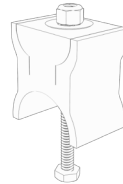

3. Deutch "whip"

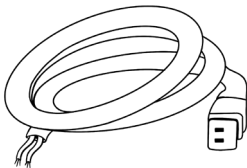

4. Replacement GORE PolyVent



REFERENCES



For additional information, please visit hivizleds.com



Single Stack
Product Page





HiViz LED LIGHTING
HiViz Lighting, Inc
Phone: 703-662-3458
Email: firetech@hivizleds.com
PO Box 565, Naples, NC 28760